

RXG SERIES LED DRIVERS

DL-250H-RXG_V1.0

A decorative graphic at the bottom of the page consisting of several overlapping teal waves. The topmost wave features a white circuit board pattern with lines and dots, suggesting electronic components or a PCB layout.

Guangdong Dongling Electronic Technology Co., Ltd

Features

- Class I structure
- Input voltage: 200-277VAC ~ 50/60Hz
- Efficiency :93%(Typ.)
- Constant power drive and constant current voltage control mode
- Metal shell structure, protection grade: IP67
- Lightning protection level: differential mode 4kV, common mode 6kV
- All-round protection: output temperature, output over-voltage, output over-current, short circuit protection
- 5 years warranty

Product introduction

Dongling DL-250H-RXG series is a series of constant voltage products with output power of 250W. Can operate in the input voltage range of 180-305Vac, and provide 24Vdc, 0-10.42A current range output, with perfect output overtemperature, overvoltage, overcurrent, overload, short circuit protection. The product is designed with IP67 protection grade. The aluminum shell greatly improves the heat dissipation efficiency of the product and increases the reliability of outdoor applications. Provide reliable power supply solutions for outdoor landscape lighting, architectural lighting, and advertising sign lighting.

Model list

Model NO.	Input voltage	Output power	Output voltage	The default current	Eff. (Typ.)	T.H.D	PF
DL-250H-V24-RXG	200-277VAC 50/60Hz	250W	24Vdc	0-10.42A	≥93%	< 10%	0.95

Note :

1. Test conditions of the above parameters: Ta=25℃, 230Vac input, full load operation for 30 minutes;
2. Including setting error, linear adjustment rate and load adjustment rate;
3. Power supply is used as a component with terminal equipment. EMC is affected by the whole set of devices. Terminal equipment manufacturers need to re-confirm the EMC for the whole set of devices.

Input characteristics

Parameter	Min	Typ.	Max	Note
Rated input voltage	200Vac 250Vdc	230Vac	277Vac 400Vdc	
Input voltage range	180Vac	-	305Vac	
Rated frequency	47Hz	50/60Hz	63Hz	
Power factor	-	0.95	-	100% load, 230Vac input
Power factor	-	0.94	-	75% load, 230Vac input
T.H.D.	-	-	10%	100% load, 230Vac input
T.H.D.	-	-	20%	75% load, 230Vac input
Input current	-	-	1.16A	@180Vac full load
Inrush current	-	-	129A	230Vac, cold start (25°C)
16A Circuit breaker The number of power supplies of the same model can be configured	3pcs (Type B circuit breaker) 4pcs (Type C circuit breaker) for 230Vac input			

Output characteristic

Parameter	Min	Typ.	Max	Note
Rated current DL-250H-V24-RXG	-	10.42A	-	
Output current range DL-250H-V24-RXG	0	-	10.42A	
Output voltage range DL-250H-V24-RXG	-	24V	-	
Rated power(200-277Vac)	-	250W	-	
No-load voltage DL-250H-V24-RXG	-	-	24.5V	
Efficiency@200Vac DL-250H-V24-RXG	92%	93%	-	full load @200Vac

Output characteristic

Parameter	Min	Typ.	Max	Note
Efficiency@230Vac DL-250H-V24-RXG	93%	94%	-	full load @230Vac
Output voltage Ripple	-	<3%	-	100% load
Accuracy of output voltage	-2%	-	+2%	full load
Line regulation	-2%	-	+2%	full load
Load regulation	-2%	-	+2%	full load
Starting time	-	-	120ms	Full load@230Vac

Protection

Function	Function instructions
Output overload protection	Protection mode:hiccup mode,recovers automatically after fault condition is removed.
Output short circuit protection	Hiccup mode:recovers automatically after fault condition is removed
Over temperature protection	Self-recovery type: when the housing temperature is greater than 90℃, the output power decreases gradually.
Output over-voltage protection	output voltage > works voltage 1.08-1.2 times turn-off
Output over-current protection	Output current >1.08-1.3times turn-off

Environmental

Environmental categories	Parameter
Working temperature	-40 ~ +55℃@200-277Vac, (refer to "Life Curve ")
Max.Case Temp.	-40 ~ 90℃
Working humidity	20 ~ 95% RH, non condensing
Storage temperature、humidity	-40 ~ +80℃, 10 ~ 95% RH
Resistant to vibration	10 ~ 500Hz, 5G 12 min/cycle, X, Y, Z axis 72 min each
MTBF	230Khrs min. MIL-HDBK-217F (Ta=25℃)
Lifetime	70,000 hours @Tcase≤75℃,230Vac, 80% Load, Please refer to "Tcase VS Lifetime" section

Safety and EMC

Safety categories	Standard
Safety	GB19510.1、GB19510.14、EN61347-1、EN61347-2-13、IEC61347-1、IEC61347-2-13、AS/NZS61347.1、AS61347.2.13、EN 62384、UL8750;
EMC	EN 55015、EN 61000-3-2 、GB/T 17743、GB17625.1、EN 61000-3-3
Surge protection	Differential mode L-N ±4KV (2 ohm) ,common mode L, N-PE± 6 KV (12 ohm); Refer to IEC61000-4-5 2014
High-pot test	I/P-O/P:3.75KVac I/P-PE :1.5KVac O/P-PE : 0.5KVac
Insulation impedance	I/P-PE:100MΩ / 500VDC; I/P-O/P:100MΩ / 500VDC / 25℃/ 70% RH
Leakage current	<0.7mA@277Vac

Inrush current

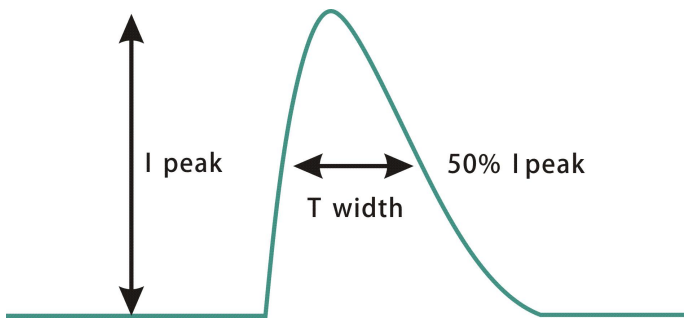

Input voltage	Peak current	T(@50% Peak current)
200Vac	86A	166us
230Vac	129A	138us
277Vac	127A	168us

DL-250H-V24-RXG Parametric curves

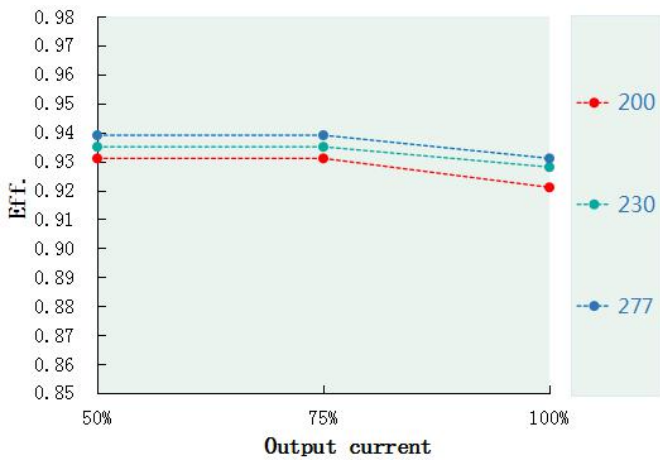

Eff. VS Output current

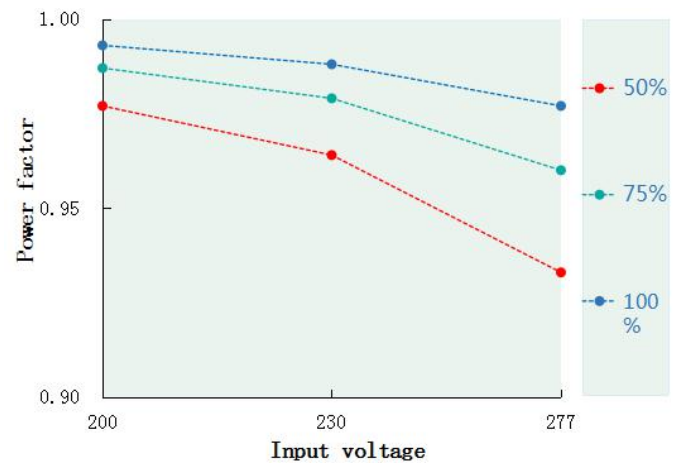

Power factor VS Input voltage

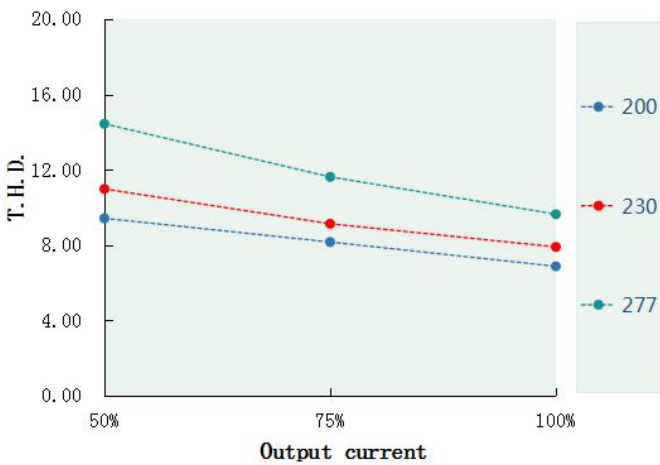

T.H.D. VS Output current

DL-250H-V24-RXG Parametric curves

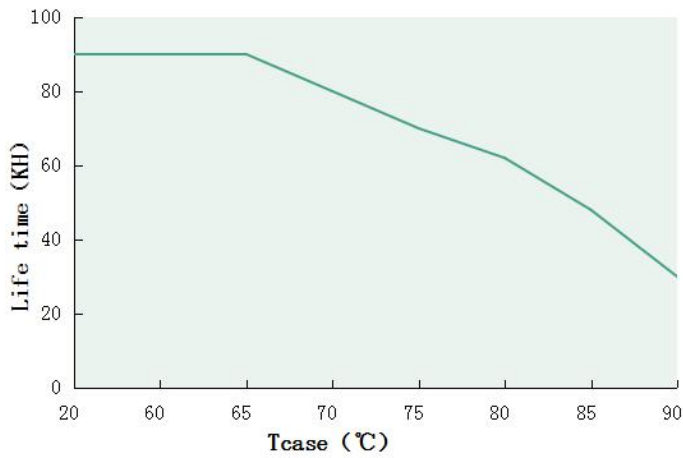

Lifetime VS Tcase

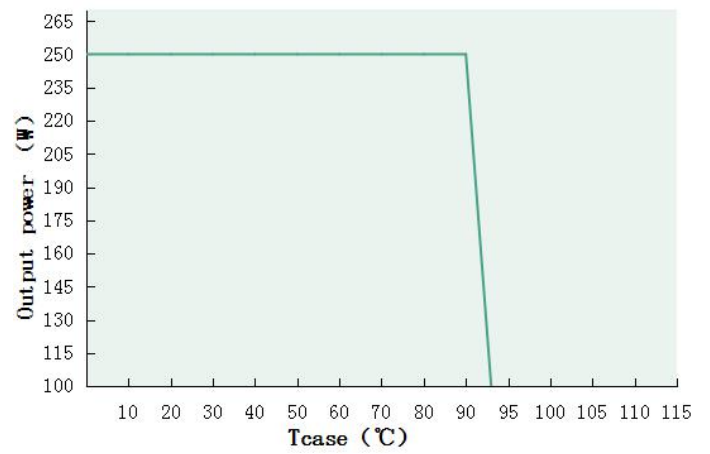

Output power VS Tcase

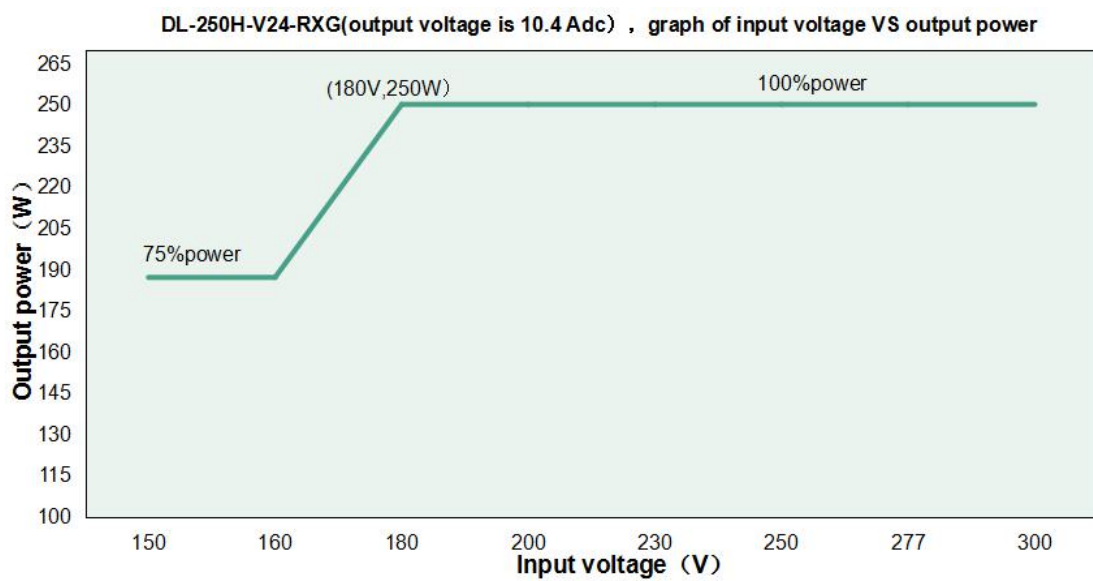

Output power VS Input voltage

Note: If the input voltage is lower than 180Vac, the output power should be derated to 75% of the load.

Mechanical specification

Size (mm)

L138mm*W63mm*H32mm

0.857KG

DL-250H-V24-RXG

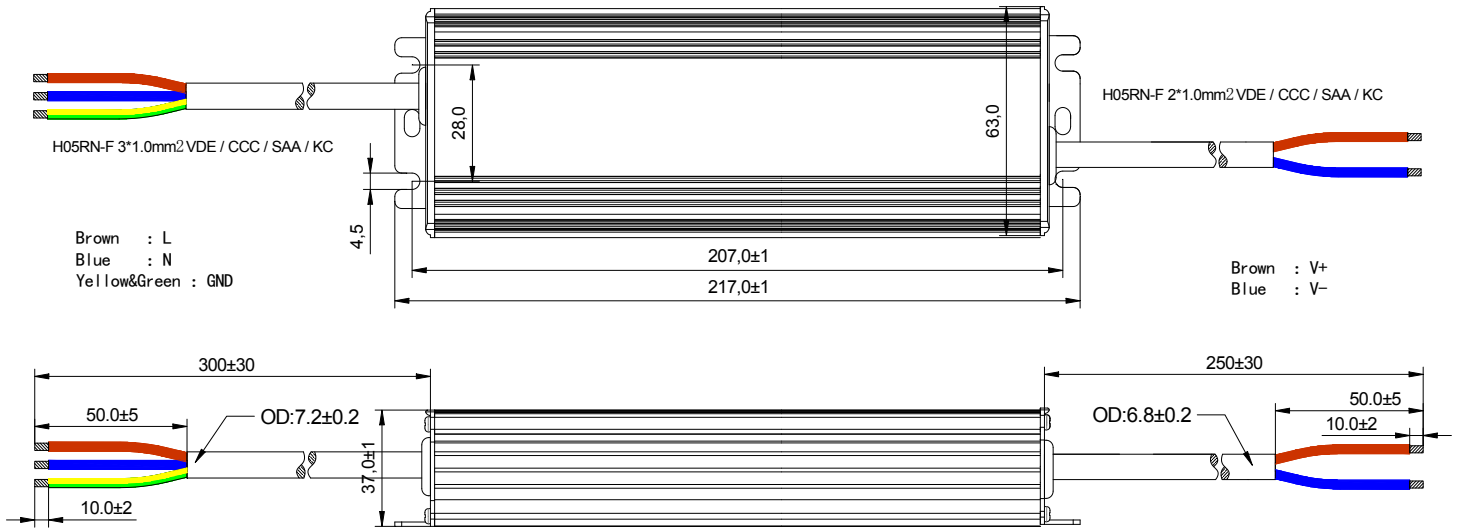

Packaging

Packaging (mm) L475*W350*H160

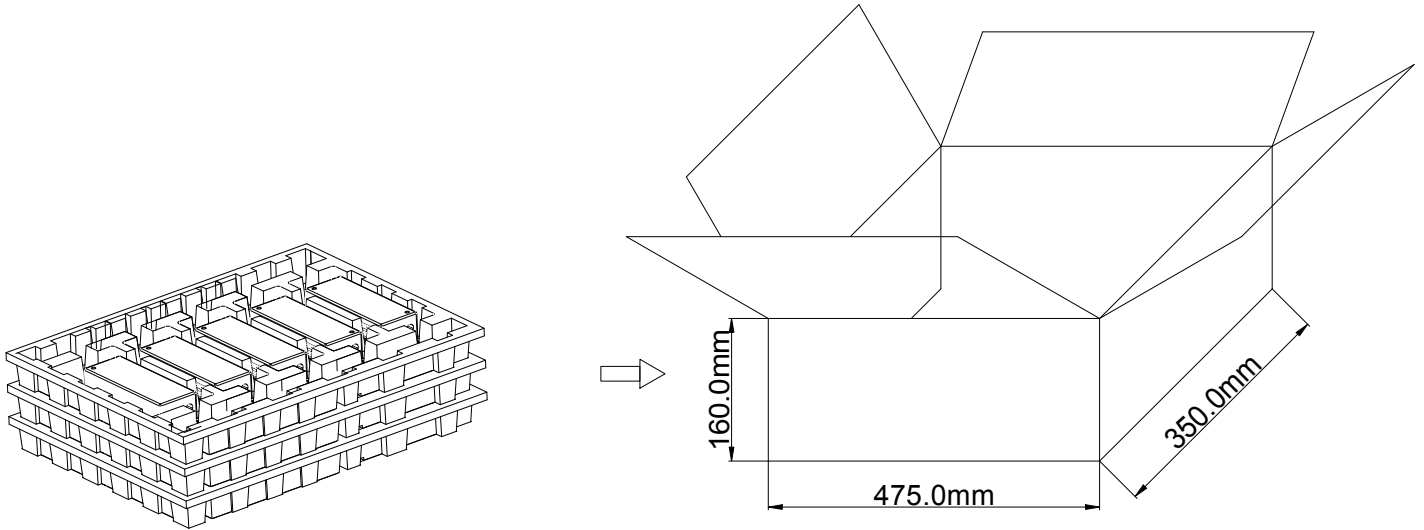

Note: One Carton 3 layers and 5pcs each layer, total 15pcs/carton.

Note:

1. According to the certificate obtained by the LED DRIVER, the LED DRIVER with the English label is sold in Europe, America and India.
2. The LED DRIVER with Chinese label is only used for China market.

Version

DATE	DESCRIPTION	REV.	CHECK
2023.03.10	Initial version.	V1.0	

MANUFACTURER

EDIT

CHECK

APPROVT

--	--	--